

Rod Kit, Iron Gland

Star Bushing - A, J, & H Cylinders	27
Pneumatic - A & C Cylinders	28
Hydraulic - AJ, J, M & H Cylinders	29

Star Rod Kits

A, J, & H Cylinders	30
---------------------------	----

Rod Cage Assembly

Hydraulic	31
-----------------	----

Hat Packing

PTFE & Nitrile	32
----------------------	----

PTFE Wiper

"U" Style - A, C, J, M, & H Cylinders	32
---	----

Iron Gland

Star Bushing Style for A, J, & H Cylinders - Retainer Held & Bolted	33
A, C, J, M, & H Cylinders - Retainer Held & Bolted	34

Retainer

A, C, J, M, & H Cylinders	35
---------------------------------	----

Caged Assembly Components

Rod Seal Cage, Wave Spring, & Bronze Pressure Ring	35
--	----

Piston Kits

A, J, & H Series Cylinders	36
----------------------------------	----

Piston Kits

HV Series Cylinders	37
---------------------------	----

Piston U-Seals

All Current Style Cylinders	37
-----------------------------------	----

Wear Rings

Air & Hydraulic Service	38
-------------------------------	----

Tube Seal Cord

A, C, J, M, & H Cylinders	38
---------------------------------	----

PTFE Tube End Seals

Continuous	39
Strip	39

Piston Cups

A, AJ, J, JW, H, & HW Cylinders	40
---------------------------------------	----

Follower Seals

PTFE	40
------------	----

MILLER

Star Bushing Rod Kit, Iron Gland

MILLER

A, J, & H Cylinders
1998 Style Retainer Held **1998 Style Bolted**

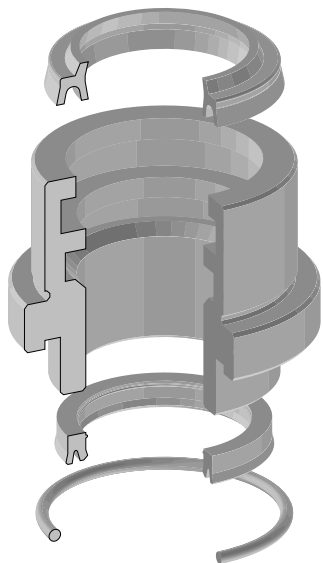

Kit Includes:
 1 XNBR Wiper
 1 Retainer Held Star Bushing
 1 URE Rod Seal
 1 NBR O-ring

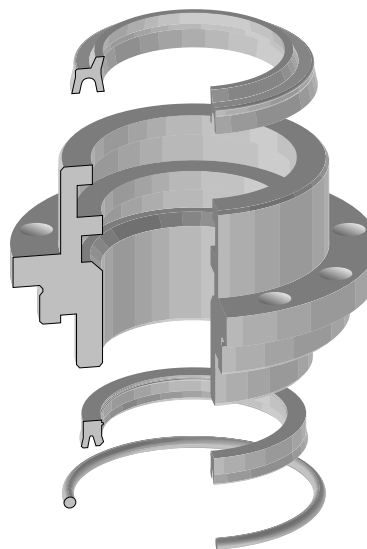

Kit Includes:
 1 XNBR Wiper
 1 Bolted Star Bushing
 1 URE Rod Seal
 1 NBR O-ring

Rod Dia.	Kit #	List Price	Kit #	List Price
5/8"	MLR-051-KR074-063	\$ 95.79	MLR-051-KR075-063	\$ 128.67
1"	MLR-051-KR074-100	119.18	MLR-051-KR075-100	155.18
1-3/8"	MLR-051-KR074-138	140.51	MLR-051-KR075-138	181.90
1-3/4"	—		MLR-051-KR075-175	197.13
2"	—		MLR-051-KR075-200	234.47
2-1/2"	—		MLR-051-KR075-250	321.93
3"	—		MLR-051-KR075-300	414.40
3-1/2"	—		MLR-051-KR075-350	555.80
4"	—		MLR-051-KR075-400	600.53
4-1/2"	—		MLR-051-KR075-450	646.33
5"	—		MLR-051-KR075-500	860.27
5-1/2"	—		MLR-051-KR075-550	1215.67

Bolted bushings from: 5/8" to 1-3/4" have 4 bolt holes
 2" to 4-1/2" have 8 bolt holes
 5" to 5-1/2" have 12 bolt holes

MILLER

Pneumatic Rod Kit, Iron Gland

A & C Cylinders

Retainer Held

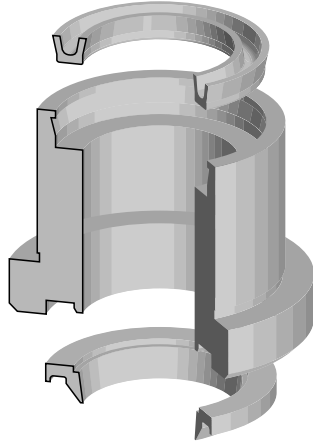
**Kit Includes:**

- 1 PTFE Wiper
- 1 Retainer Held Iron Gland
- 1 NBR Hat Packing

Bolted

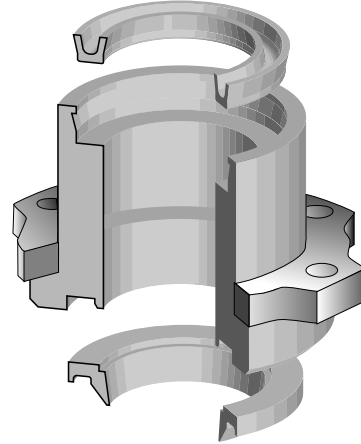
**Kit Includes:**

- 1 PTFE Wiper
- 1 Bolted Iron Gland
- 1 NBR Hat Packing

Rod Dia.	Kit #	List Price	Kit #	List Price
5/8"	MLR-051-KR010-063	\$ 42.10	MLR-051-KR011-063	\$ 59.57
1"	MLR-051-KR010-100	52.57	MLR-051-KR011-100	72.56
1-3/8"	MLR-051-KR010-138	64.35	MLR-051-KR011-138	89.53
1-3/4"	MLR-051-KR010-175	94.53	MLR-051-KR011-175	133.12
2"	MLR-051-KR010-200	110.57	MLR-051-KR011-200	142.28
2-1/2"	MLR-051-KR010-250	159.10	MLR-051-KR011-250	207.10
3"	MLR-051-KR010-300	209.69	MLR-051-KR011-300	248.55

Bolted bushings from: 5/8" to 1-3/4" have 4 bolt holes
 2" to 4-1/2" have 8 bolt holes
 5" to 5-1/2" have 12 bolt holes

MILLER

Hydraulic Rod Kit, Iron Gland

AJ, J, M, & H Cylinders

Retainer Held

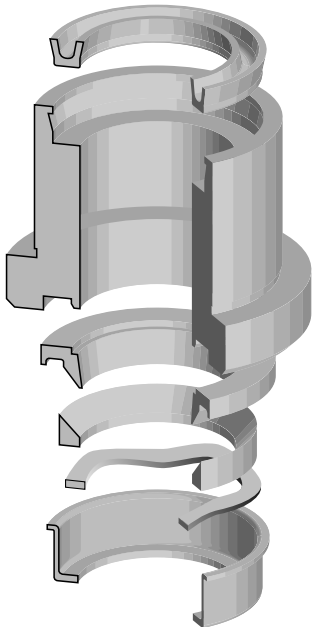

- Kit Includes:**
 1 PTFE Wiper
 1 Retainer Held Iron Gland
 1 PTFE Hat Packing
 1 Bronze Pressure Ring
 1 Wave Spring
 1 Cage

Bolted

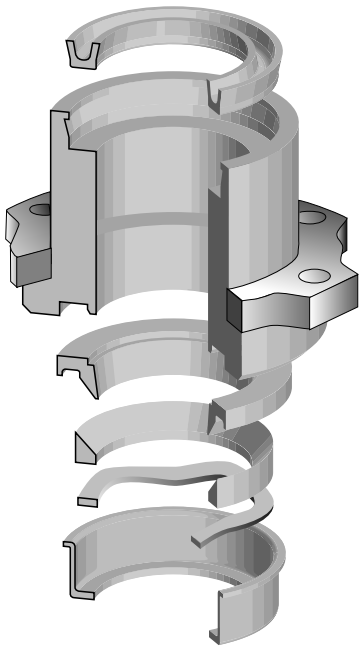

- Kit Includes:**
 1 PTFE Wiper
 1 Bolted Iron Gland
 1 PTFE Hat Packing
 1 Bronze Pressure Ring
 1 Wave Spring
 1 Cage

Rod Dia.	Kit #	List Price	Kit #	List Price
5/8"	MLR-051-KR014-063	\$ 75.41	MLR-051-KR015-063	\$ 93.21
1"	MLR-051-KR014-100	92.95	MLR-051-KR015-100	112.21
1-3/8"	MLR-051-KR014-138	114.26	MLR-051-KR015-138	138.92
1-3/4"	MLR-051-KR014-175	154.79	MLR-051-KR015-175	176.83
2"	MLR-051-KR014-200	186.79	MLR-051-KR015-200	209.91
2-1/2"	MLR-051-KR014-250	232.43	MLR-051-KR015-250	271.42
3"	MLR-051-KR014-300	307.02	MLR-051-KR015-300	338.95

Bolted bushings from: 5/8" to 1-3/4" have 4 bolt holes
 2" to 4-1/2" have 8 bolt holes
 5" to 5-1/2" have 12 bolt holes

MILLER**Star Rod Kits****A, J, & H Cylinders
Star Kits**

Rod Dia.	Kit #	List Price
5/8"	MLR-051-KR080-063	\$ 11.39
1"	MLR-051-KR080-100	20.11
1-3/8"	MLR-051-KR080-138	26.72
1-3/4"	MLR-051-KR080-175	33.11
2"	MLR-051-KR080-200	37.17
2-1/2"	MLR-051-KR080-250	44.39
3"	MLR-051-KR080-300	79.94
3-1/2"	MLR-051-KR080-350	85.67
4"	MLR-051-KR080-400	96.22
4-1/2"	MLR-051-KR080-450	108.78
5"	MLR-051-KR080-500	116.28
5-1/2"	MLR-051-KR080-550	181.72

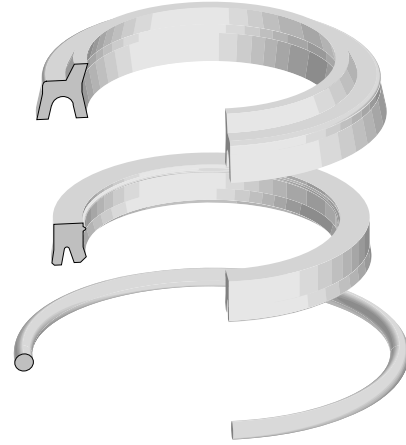
**Kit Includes:**

- 1 XNBR Wiper
- 1 URE Rod Seal
- 1 NBR O-ring

MILLER

Hydraulic Rod Seal Cage Assembly

MILLER

AJ, J, M, & H Cylinders Boosters & Tandems

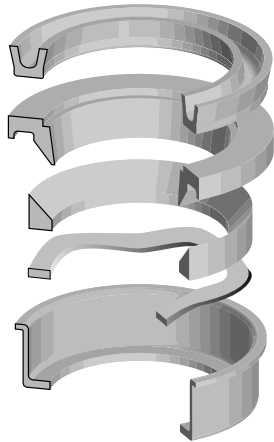

Kit Includes:

- 1 PTFE Wiper
- 1 PTFE Hat Packing
- 1 Bronze Pressure Ring
- 1 Wave Spring
- 1 Cage

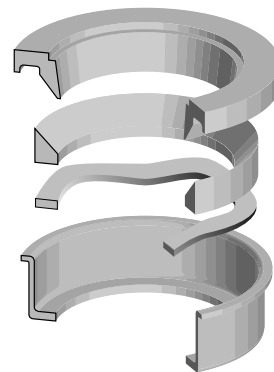

Kit Includes:

- 1 PTFE Hat Packing
- 1 Bronze Pressure Ring
- 1 Wave Spring
- 1 Cage
- No Wiper

Rod Dia.	Kit #	List Price	Kit #	List Price
5/8"	MLR-051-KR012-063	\$ 42.46	MLR-051-KR024-063	\$ 38.49
1"	MLR-051-KR012-100	50.82	MLR-051-KR024-100	46.11
1-3/8"	MLR-051-KR012-138	62.93	MLR-051-KR024-138	56.99
1-3/4"	MLR-051-KR012-175	76.43	MLR-051-KR024-175	69.20
2"	MLR-051-KR012-200	89.23	MLR-051-KR024-200	80.99
2-1/2"	MLR-051-KR012-250	111.09	MLR-051-KR024-250	96.75
3"	MLR-051-KR012-300	148.74	MLR-051-KR024-300	132.72

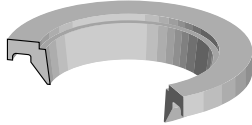
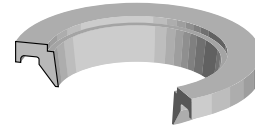
MILLER**Hat Packing****For Hydraulic Service
PTFE****For Air & Water Service
Nitrile**

Rod Dia.	Part #	List Price	Part #	List Price
5/8"	MLR-051-RS007-063	\$ 5.50	MLR-051-RS014-063	\$ 4.34
1"	MLR-051-RS007-100	7.08	MLR-051-RS014-100	5.72
1-3/8"	MLR-051-RS007-138	8.33	MLR-051-RS014-138	7.08
1-3/4"	MLR-051-RS007-175	8.78	MLR-051-RS014-175	8.94
2"	MLR-051-RS007-200	9.08	MLR-051-RS014-200	11.05
2-1/2"	MLR-051-RS007-250	11.63	MLR-051-RS014-250	14.50
3"	MLR-051-RS007-300	16.20	MLR-051-RS014-300	16.00
3-1/2"	MLR-051-RS007-350	20.65	MLR-051-RS014-350	22.95
4"	MLR-051-RS007-400	22.22	MLR-051-RS014-400	27.29
4-1/2"	MLR-051-RS007-450	25.86	MLR-051-RS014-450	31.50
5"	MLR-051-RS007-500	27.83	MLR-051-RS014-500	35.79
5-1/2"	MLR-051-RS007-550	32.67	MLR-051-RS014-550	40.00

PTFE Wiper "U" Style**A, C, J, M, & H Cylinders**

Rod Dia.	Part #	List Price
5/8"	MLR-051-WP001-063	\$ 3.97
1"	MLR-051-WP001-100	4.71
1-3/8"	MLR-051-WP001-138	5.94
1-3/4"	MLR-051-WP001-175	7.22
2"	MLR-051-WP001-200	8.24
2-1/2"	MLR-051-WP001-250	14.34
3"	MLR-051-WP001-300	16.01
3-1/2"	MLR-051-WP001-350	18.09
4"	MLR-051-WP001-400	20.54
4-1/2"	MLR-051-WP001-450	26.89
5"	MLR-051-WP001-500	28.97
5-1/2"	MLR-051-WP001-550	29.47

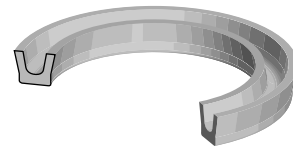

MILLER

MILLER

Iron Gland

Star Bushing Style A, J, & H Cylinders

Retainer Held

Bolted

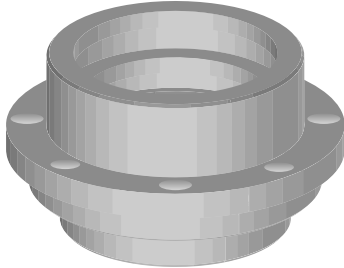
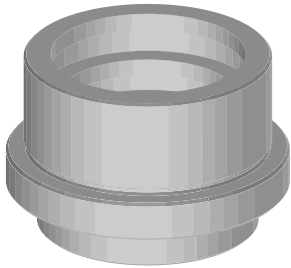

Rod Dia.	Part #	List Price	Part #	List Price
5/8"	MLR-050-BU100-063	\$ 40.14	MLR-050-BU101-063	\$ 87.20
1"	MLR-050-BU100-100	44.01	MLR-050-BU101-100	105.82
1-3/8"	MLR-050-BU100-138	56.86	MLR-050-BU101-138	125.60
1-3/4"	—		MLR-050-BU101-175	111.82
2"	—		MLR-050-BU101-200	156.12
2-1/2"	—		MLR-050-BU101-250	220.81
3"	—		MLR-050-BU101-300	245.18
3-1/2"	—		MLR-050-BU101-350	289.57
4"	—		MLR-050-BU101-400	426.50
4-1/2"	—		MLR-050-BU101-450	461.50
5"	—		MLR-050-BU101-500	524.39
5-1/2"	—		MLR-050-BU101-550	574.67

Bolted bushings from: 5/8" to 1-3/4" have 4 bolt holes
 2" to 4-1/2" have 8 bolt holes
 5" to 5-1/2" have 12 bolt holes

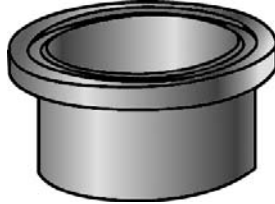
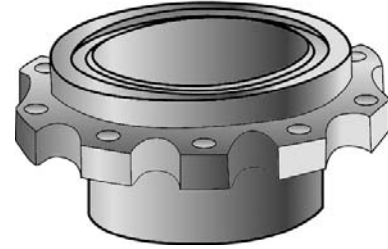
MILLER**Iron Gland****A, C, J, M, & H Cylinders****Retainer Held****Bolted**

Rod Dia.	Part #	List Price	Part #	List Price
5/8"	MLR-050-BU022-063	\$ 35.97	MLR-050-BU024-063	\$ 78.95
1"	MLR-050-BU022-100	45.09	MLR-050-BU024-100	95.11
1-3/8"	MLR-050-BU022-138	54.72	MLR-050-BU024-138	122.39
1-3/4"	MLR-050-BU022-175	78.36	MLR-050-BU024-175	123.78
2"	MLR-050-BU022-200	97.55	MLR-050-BU024-200	138.92
2-1/2"	MLR-050-BU022-250	121.34	MLR-050-BU024-250	160.34
3"	MLR-050-BU022-300	158.29	MLR-050-BU024-300	190.21

Bolted bushings from: 5/8" to 1-3/4" have 4 bolt holes
 2" to 4-1/2" have 8 bolt holes
 5" to 5-1/2" have 12 bolt holes

MILLER

Retainer

A, C, J, M, & H Cylinders

Rod Dia.	Part #	List Price
5/8"	MLR-050-RT005-063	\$ 24.18
1"	MLR-050-RT005-100	26.96
1-3/8"	MLR-050-RT005-138	34.44



For Caged Assemblies

Rod Seal Cage	Wave Spring	Bronze Pressure Ring
---------------	-------------	----------------------

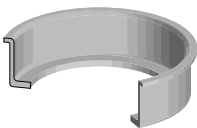

Rod Dia.	Part #	List Price	Part #	List Price	Part #	List Price
5/8"	MLR-051-CG001-063	\$ 11.79	MLR-051-WS004-063	\$ 10.25	MLR-051-PG001-063	\$ 14.01
1"	MLR-051-CG001-100	13.98	MLR-051-WS004-100	10.25	MLR-051-PG001-100	17.51
1-3/8"	MLR-051-CG001-138	15.65	MLR-051-WS004-138	10.25	MLR-051-PG001-138	26.01
1-3/4"	MLR-051-CG001-175	16.53	MLR-051-WS004-175	10.25	MLR-051-PG001-175	35.32
2"	MLR-051-CG001-200	18.13	MLR-051-WS003-200	12.48	MLR-051-PG001-200	41.29
2-1/2"	MLR-051-CG001-250	20.50	MLR-051-WS003-250	13.13	MLR-051-PG001-250	51.48
3"	MLR-051-CG001-300	28.60	MLR-051-WS003-300	15.73	MLR-051-PG001-300	72.09

MILLER

Piston Kits

A Series Cylinders

January '82 to Current

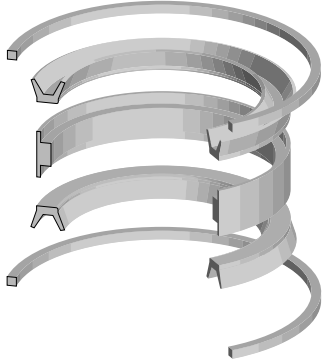

Kit Includes:

2 NBR U-seals
1 Wear Ring
2 PTFE Tube End Seals
(wear ring material and profile varies with size)

J Series Cylinders

January '81 to Current

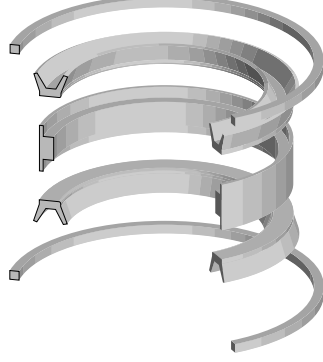

Kit Includes:

2 U-seals (1-PTFE up to 5", 1-NBR from 6" to 12")
1 Wear Ring
2 PTFE Tube End Seals
(wear ring and u-seal material and profile varies with size)

H Series Cylinders

January '82 to Current

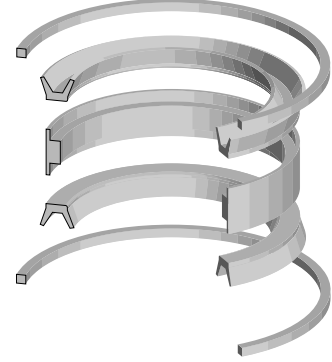

Kit Includes:

2 PTFE U-seals
1 T-Shape Wear Ring
2 PTFE Tube End Seals
(wear ring material varies with size)

Bore Dia.	Kit #	List Price	Kit #	List Price	Kit #	List Price
1-1/2"	MLR-090-KB001-150	\$ 44.93	MLR-091-KB001-150	\$ 51.72	MLR-171-KB001-150	\$ 70.87
2"	MLR-090-KB001-200	57.57	MLR-091-KB001-200	52.02	MLR-171-KB001-200	82.11
2-1/2"	MLR-090-KB001-250	62.46	MLR-091-KB001-250	60.57	MLR-171-KB001-250	98.69
3-1/4"	MLR-090-KB001-325	70.79	MLR-091-KB001-325	79.46	MLR-171-KB001-325	117.36
4"	MLR-090-KB001-400	81.87	MLR-091-KB001-400	87.42	MLR-171-KB001-400	162.04
5"	MLR-090-KB001-500	87.00	MLR-091-KB001-500	123.00	MLR-171-KB001-500	188.22
6"	MLR-090-KB001-600	104.78	MLR-091-KB001-600	131.44	MLR-171-KB001-600	211.53
7"	MLR-090-KB001-700	110.94	MLR-091-KB001-700	135.42	MLR-171-KB001-700	298.12
8"	MLR-090-KB001-800	114.08	MLR-091-KB001-800	145.87	MLR-171-KB001-800	372.17
10"	MLR-090-KB001-1000	127.97	MLR-091-KB001-1000	162.74	MLR-171-KB001-1000	438.25
12"	MLR-090-KB001-1200	146.64	MLR-091-KB001-1200	206.83	MLR-171-KB001-1200	496.06

MILLER

MILLER

Piston Kits

HV Series Cylinders Urethane

Bore Dia.	(URE) Kit #	List Price
1-1/2"	MLR-181-KB001-150	\$ 31.31
2"	MLR-181-KB001-200	32.64
2-1/2"	MLR-181-KB001-250	34.12
3-1/4"	MLR-181-KB001-325	37.79
4"	MLR-181-KB001-400	40.66
5"	MLR-181-KB001-500	48.14
6"	MLR-181-KB001-600	55.71
7"	MLR-181-KB001-700	56.42
8"	MLR-181-KB001-800	80.47

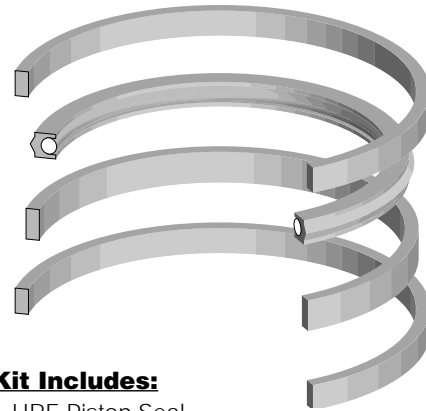

Kit Includes:
 1 URE Piston Seal
 1 Wear Ring
 2 PTFE Tube End Seals

Piston U-Seals

All Current Style Cylinders

Buna-N

PTFE

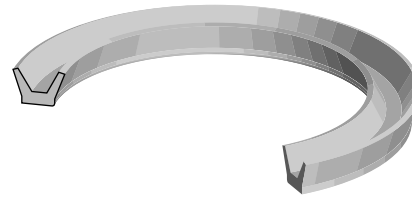
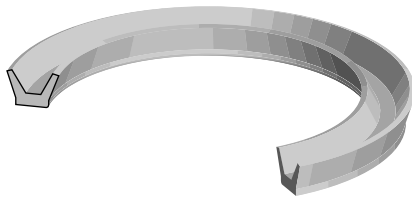

Bore Dia.	Part #	List Price	Part #	List Price
1-1/2"	MLR-052-PS025-150	\$ 6.35	MLR-052-PS017-150	\$ 9.05
2"	MLR-052-PS025-200	7.19	MLR-052-PS017-200	9.12
2-1/2"	MLR-052-PS025-250	7.66	MLR-052-PS017-250	10.76
3-1/4"	MLR-052-PS025-325	9.05	MLR-052-PS017-325	14.04
4"	MLR-052-PS025-400	12.66	MLR-052-PS017-400	18.61
5"	MLR-052-PS025-500	15.07	MLR-052-PS017-500	27.91
6"	MLR-052-PS025-600	19.30	MLR-052-PS017-600	31.92
7"	—	—	MLR-052-PS017-700	38.78
8"	—	—	MLR-052-PS017-800	45.17
10"	—	—	MLR-052-PS017-1000	71.33
12"	—	—	MLR-052-PS017-1200	95.67

MILLER

Wear Rings

Air Service PTFE

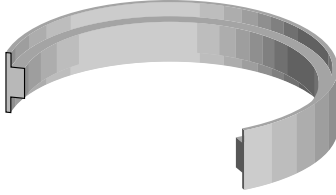

Hydraulic Service Acetal

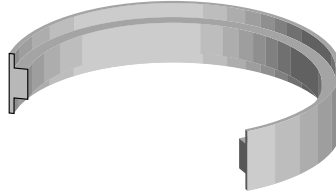

Hydraulic Service Bronze

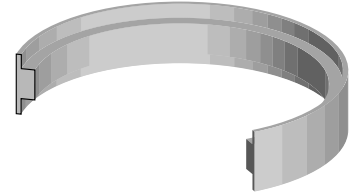

Bore Dia.	Part #	List Price	Part #	List Price	Part #	List Price
1-1/2"	—	—	MLR-052-WR009-150-25	\$ 13.83	—	—
2"	—	—	MLR-052-WR009-200-25	15.91	—	—
2"	—	—	MLR-052-WR009-200-31	16.16	—	—
2-1/2"	—	—	MLR-052-WR009-250-25	19.57	—	—
2-1/2"	—	—	MLR-052-WR009-250-38	20.79	—	—
3-1/4"	MLR-052-WR005-325-25	\$ 21.49	MLR-052-WR009-325-25	26.79	—	—
3-1/4"	—	—	MLR-052-WR009-325-50	29.73	—	—
4"	MLR-052-WR005-400-25	26.83	MLR-052-WR009-400-25	31.09	—	—
4"	—	—	MLR-052-WR009-400-63	42.02	—	—
5"	MLR-052-WR005-500-25	33.67	MLR-052-WR009-500-75	83.56	—	—
6"	MLR-052-WR005-600-25	40.24	MLR-052-WR009-600-75	108.22	—	—
7"	—	—	—	—	MLR-052-WR008-700-75	\$ 113.00
8"	—	—	—	—	MLR-052-WR008-800-125	151.28
10"	—	—	—	—	MLR-052-WR008-1000-125	176.50
12"	—	—	—	—	MLR-052-WR008-1200-125	193.22

PTFE Tube Seal Cord

A, C, J, M, & H Cylinders



Part #	Radial Wall	Width	List Price
MLR-008-SH001	.030	.070	\$ 51.08
Includes: 30' spool of PTFE Head Seal			
MLR-SH1-STRIP	.030	.070	4.05 ft

MILLER

Tube End Seals

Continuous PTFE

A, C, J, M, ER500, & ER3000

H & ER6000

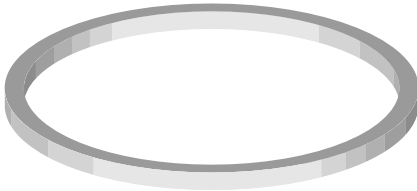
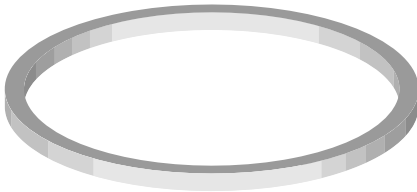

Bore Dia.	Part #	List Price	Part #	List Price
1-1/2"	MLR-090-ES009-150	\$ 4.78	MLR-170-ES010-150	\$ 7.35
2"	MLR-090-ES009-200	8.72	MLR-170-ES010-200	10.40
2-1/2"	MLR-090-ES009-250	8.76	MLR-170-ES010-250	13.49
3-1/4"	MLR-090-ES009-325	8.83	MLR-170-ES010-325	14.06
4"	MLR-090-ES009-400	13.06	MLR-170-ES010-400	16.82
5"	MLR-090-ES009-500	16.45	MLR-170-ES010-500	20.15
6"	MLR-090-ES009-600	20.49	MLR-170-ES010-600	23.32
7"	MLR-090-ES009-700	25.72	MLR-170-ES010-700	26.48
8"	MLR-090-ES009-800	32.02	MLR-170-ES010-800	33.15
10"	MLR-090-ES009-1000	38.19	MLR-170-ES010-1000	38.49
12"	MLR-090-ES009-1200	42.50	MLR-170-ES010-1200	42.88

Tube End Seals

Strip PTFE

A, C, J, M, ER500, & ER3000

H & ER6000

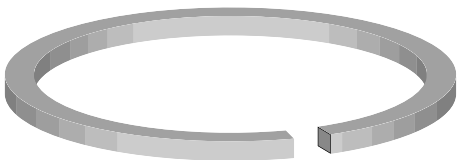
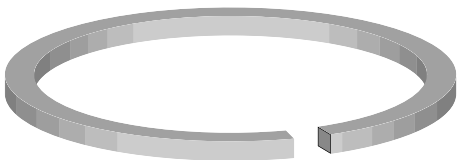

Bore Dia.	Part #	List Price	Part #	List Price
1-1/2"	MLR-090-ES006-150	\$ 3.86	MLR-170-ES006-150	\$ 3.80
2"	MLR-090-ES006-200	7.00	MLR-170-ES006-200	6.90
2-1/2"	MLR-090-ES006-250	7.08	MLR-170-ES006-250	7.00
3-1/4"	MLR-090-ES006-325	8.18	MLR-170-ES006-325	7.22
4"	MLR-090-ES006-400	10.15	MLR-170-ES006-400	10.29
5"	MLR-090-ES006-500	10.87	MLR-170-ES006-500	10.84
6"	MLR-090-ES006-600	13.43	—	

MILLER

Piston Cups

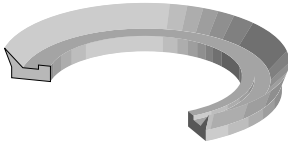
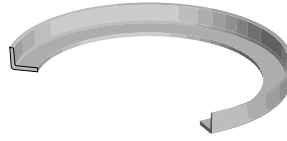
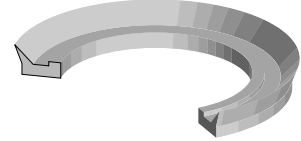
**A, JW, & HW Cylinders
From 1956-1977
Nitrile**

**J & H Cylinders
From 1956-1977
Leather**

**AJ, J, & H Cylinders
From 1956-1977
PTFE**

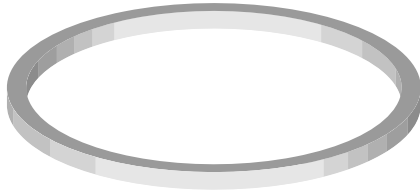
Bore Dia.	Part #	List Price	Part #	List Price	Part #	List Price
1-1/2"	MLR-052-PS001-150	\$ 7.19	MLR-052-PS003-150	\$ 11.53	MLR-052-PS006-150	\$ 10.40
2"	MLR-052-PS001-200	7.69	MLR-052-PS003-200	14.15	MLR-052-PS006-200	12.55
2-1/2"	MLR-052-PS001-250	10.51	MLR-052-PS003-250	18.94	MLR-052-PS006-250	18.68
3-1/4"	MLR-052-PS001-325	16.42	MLR-052-PS003-325	29.75	MLR-052-PS006-325	24.19
4"	MLR-052-PS001-400	19.15	MLR-052-PS003-400	36.63	MLR-052-PS006-400	29.88
5"	MLR-052-PS001-500	24.81	MLR-052-PS003-500	50.95	MLR-052-PS006-500	44.76
6"	MLR-052-PS001-600	28.20	MLR-052-PS003-600	69.07	MLR-052-PS006-600	54.10
8"	MLR-052-PS001-800	32.22	—	—	—	—
10"	MLR-052-PS001-1000	38.50	—	—	—	—

PTFE Follower Seals

**J & H Cylinders
From 1956-1977**

Part #	I.D.	Radial Wall	Width	List Price
MLR-052-FS001-44	7/16	.07	.07	\$ 3.64
MLR-052-FS001-75	3/4	.07	.07	4.96
MLR-052-FS001-100	1	.14	.14	7.69
MLR-052-FS001-125	1-1/4	.14	.14	8.54
MLR-052-FS001-150	1-1/2	.145	.14	10.81

Various Kits

Kit #	Rod x Bore	List Price
MLR-150-KB001-325	3-1/4	\$ 128.75
MLR-150-KB001-500	5	218.69

Kit Composition Varies

Consult your sales representative.