

Two Piece Piston Seals

Ordering Information

Part Number: Prefix - OD X W X CS1

Example: MPSU - 25 X 3.0 X 2.0

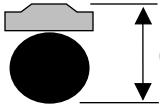

Sizes and styles are in stock where prices are shown.

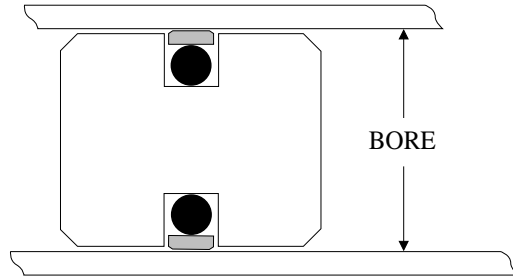

CS2

Dimension CS2 is the free state cross section only. It is not the groove dimension.

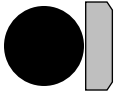

<i>Styles</i>	
	MPS
Piston Seal:	PTFE
Energizer:	Nitrile 70
Temperature:	-40 to +230° F
Pressure:	0 to 5,000 PSI
	MPSU
Piston Seal:	Urethane
Energizer:	Nitrile 70
Temperature:	-40 to +230° F
Pressure:	0 to 5,000 PSI

OD	W	CS1	CS2	MPS	MPSU
25.0	3.0	2.0	4.62		\$ 3.90
30.0	3.0	2.0	4.62		4.33
32.0	3.0	2.0	4.62	\$12.38	
40.0	4.0	2.9	6.43		4.83
45.0	3.8	1.5	5.00	7.66	
45.0	4.0	2.9	6.43		4.95
45.0	4.3	2.0	6.52	9.25	
45.0	4.4	1.2	4.70	8.78	
50.0	2.7	2.5	5.12	8.38	
50.0	3.8	1.5	4.00	10.66	
50.0	4.0	2.9	6.43		5.18
50.0	4.3	2.0	5.53	14.80	
50.0	4.4	1.2	4.73	11.77	
50.0	6.0	3.5	8.80	16.00	
53.0	4.0	2.5	6.00	10.61	
55.0	4.3	2.0	7.00	14.80	
55.0	6.0	3.4	8.73	17.45	
60.0	3.8	2.0	5.50	10.40	
60.0	4.0	2.9	6.43		5.53
60.0	4.4	1.3	4.80	14.50	
60.0	4.9	2.5	6.00	12.66	
60.0	6.0	3.5	8.83	17.50	
60.0	7.0	2.5	7.83	4.39	
63.0	4.0	2.9	6.43		5.65
63.0	5.0	1.0	6.33	20.94	
63.0	6.0	3.5	8.88	17.50	
63.0	7.3	2.5	8.20	17.66	
65.0	6.0	3.5	8.83	17.86	
70.0	4.0	1.8	4.90	11.28	
70.0	4.0	2.9	6.43	17.75	6.71
70.0	6.0	2.8	7.90		6.50
70.0	6.0	3.5	8.83	18.65	
70.0	6.2	2.5	8.20	12.39	
70.0	7.0	2.5	7.83	4.94	
71.0	7.3	2.5	8.20	14.28	
75.0	4.0	2.9	6.43		7.19
75.0	6.2	2.5	8.20	16.06	
75.0	7.3	2.5	8.10	12.17	
80.0	6.0	3.5	8.83	19.00	8.07
80.0	6.2	2.5	7.83	18.34	
80.0	7.0	2.5	7.83	5.94	
80.0	7.3	2.5	8.00	20.56	

Two Piece Piston Seals

Ordering Information

Part Number: Prefix - OD X W X CS1

Example: MPSU - 25 X 3.0 X 2.0

Sizes and styles are in stock where prices are shown.

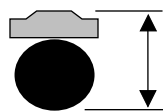

CS2

Dimension CS2 is the free state cross section only. It is not the groove dimension.

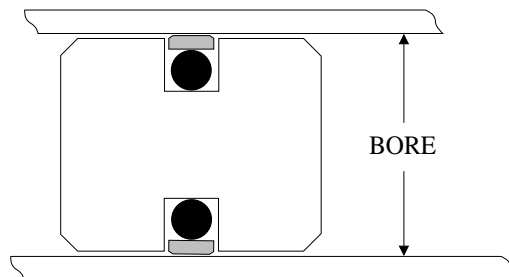

Styles

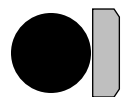

MPS

Piston Seal: PTFE
 Energizer: Nitrile 70
 Temperature: -40 to +220° F
 Pressure: 0 to 5,000 PSI

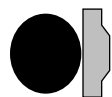

MPSU

Piston Seal: Urethane
 Energizer: Nitrile 70
 Temperature: -40 to +230° F
 Pressure: 0 to 5,000 PSI

OD	W	CS1	CS2	MPS	MPSU
80.0	7.9	5.0	12.00	\$ 22.50	
85.0	6.0	3.5	8.83	19.54	
85.0	7.9	5.0	12.00	23.00	
90.0	6.0	3.5	8.83	20.65	
90.0	7.0	2.5	7.83	6.20	
90.0	7.3	2.5	8.00	24.00	
90.0	7.9	5.0	12.00	25.50	
95.0	6.0	3.5	8.83	23.00	
95.0	7.9	5.0	12.00	26.60	
100.0	6.0	3.5	8.83	19.26	\$ 8.54
100.0	7.0	2.5	7.83	10.50	
100.0	7.9	5.0	12.00	26.38	
105.0	6.0	3.5	8.83	21.38	
105.0	7.9	5.0	12.00	25.94	
110.0	6.0	3.5	8.83	21.50	
110.0	7.0	2.5	7.83	7.36	
110.0	7.9	5.0	12.00	28.32	
115.0	6.0	3.5	8.83	22.76	
115.0	7.0	2.5	7.83	14.00	
115.0	7.9	5.0	12.00	29.00	
120.0	6.0	3.5	8.83	23.27	
120.0	7.9	5.0	12.00	29.00	
125.0	6.0	3.5	8.83	24.00	10.54
125.0	7.0	2.5	7.83	15.80	
125.0	7.9	5.0	12.00	29.00	
130.0	6.0	3.5	8.83	25.66	11.36
130.0	7.9	5.0	12.00	30.00	
135.0	7.9	5.0	12.00	33.88	
140.0	7.9	5.0	12.00	34.25	16.78
145.0	7.9	5.0	12.00	35.19	
150.0	7.9	5.0	12.00	36.84	17.50
155.0	7.9	5.0	12.00	37.68	
160.0	7.9	5.0	12.00	40.21	18.43
160.0	8.9	3.5	10.50	40.21	
165.0	7.9	5.0	12.00	44.44	
170.0	7.9	5.0	12.00	45.70	13.89
180.0	7.9	5.0	12.00	49.92	21.50
190.0	7.9	5.0	12.00	52.00	
200.0	7.9	5.0	12.00	53.56	
210.0	7.9	5.0	12.00		23.06
215.0	7.9	5.0	12.00	54.50	
225.0	7.9	5.0	12.00	59.83	
240.0	7.9	5.0	12.00	61.00	

Piston Seal Anti-Extrusion Rings

Ordering Information

Part Number: Prefix - ID X CS X W

Example: MBNP - 95 X 2.5 X 2.5

Sizes are in stock where prices are shown.

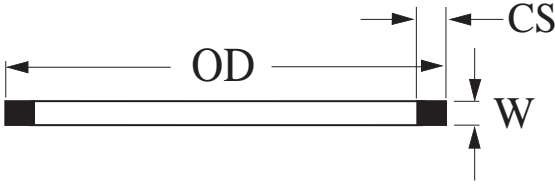

<i>Styles</i>	
	MBNP
Seal Compound:	Nylon
Temperature:	-65 to +220° F
Pressure:	0 to 5,000 PSI

OD	CS	W	MBNP
95.0	2.5	2.5	\$ 6.00
100.0	2.5	2.5	6.00
105.0	2.5	2.5	6.42
100.0	2.5	2.5	6.00
110.0	2.5	2.5	6.42
110.0	3.0	3.0	6.75
115.0	3.0	3.0	7.50
120.0	3.0	3.0	7.50
125.0	3.0	3.0	8.25
130.0	3.0	3.0	8.25
135.0	3.0	3.0	9.00
140.0	3.0	3.0	9.75
145.0	3.0	3.0	9.75
150.0	3.0	3.0	10.50
160.0	3.0	3.0	11.25
170.0	3.0	3.0	12.00
180.0	3.0	3.0	12.75
190.0	3.0	3.0	14.25

***If you don't see the size you need,
give us a call...***

We are adding new sizes everyday!



Four Piece Piston Seals

Ordering Information

Part Number: Prefix - OD X ID X W

Example: MCPS - 50 X 40 X 7.5

Sizes and styles are in stock where prices are shown.

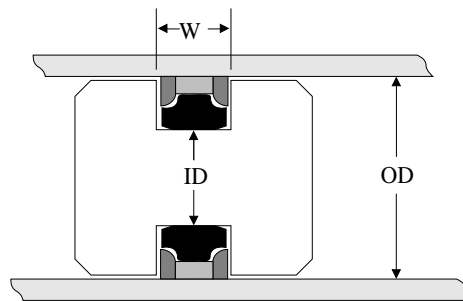

Styles



MCPS

Piston Seal: PTFE
 Back-ups: Nylon
 Energizer: Buna N
 Temperature: -20 to +225° F
 Pressure: 0 to 6,000 PSI

OD	ID	W	MCPS
50.0	40.0	7.5	\$ 27.14
60.0	46.0	8.5	26.41
65.0	51.0	8.5	41.32
70.0	55.0	10.5	26.41
70.0	60.0	7.5	25.72
75.0	60.0	10.5	25.61
75.0	63.0	8.6	27.50
80.0	65.0	10.5	28.72
80.0	65.0	11.5	28.53
85.0	70.0	10.5	33.00
90.0	75.0	10.5	33.00
90.0	75.0	11.5	31.17
95.0	80.0	10.5	33.00
100.0	85.0	12.0	35.64
105.0	90.0	12.0	36.52
110.0	95.0	12.0	37.20
115.0	100.0	12.0	41.09
120.0	100.0	15.5	54.58
120.0	105.0	12.0	38.76
125.0	102.0	15.5	43.09
125.0	105.0	15.5	59.00
130.0	107.0	15.5	46.56
135.0	112.0	15.5	49.55
140.0	117.0	15.5	52.74
140.0	120.0	15.5	66.89
145.0	122.0	15.5	53.11
150.0	127.0	15.5	57.36
160.0	137.0	15.5	65.16
160.0	140.0	15.5	59.82
165.0	142.0	15.5	72.05
170.0	147.0	15.5	73.82
180.0	157.0	15.5	68.28
180.0	160.0	15.5	66.98
185.0	162.0	15.5	71.40
190.0	167.0	15.5	86.20
200.0	177.0	15.5	80.64
225.0	202.0	15.5	102.70
250.0	222.0	17.0	109.70
260.0	232.0	17.0	109.70
280.0	252.0	17.0	123.00
300.0	272.0	17.0	163.28



Multi-Piece Piston Seals

Ordering Information

Part Number: Prefix - PN
Example: MPSA - 032A

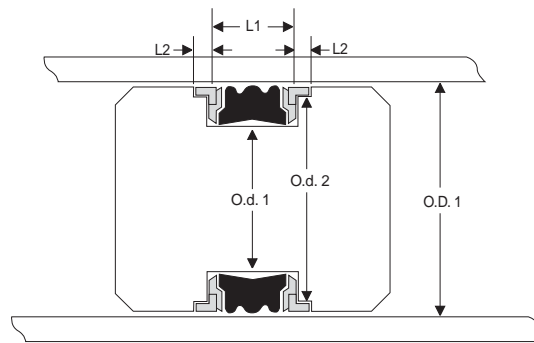
Sizes and styles are in stock where prices are shown.



Styles	
	MPSA
For 1 or 2 Piece Pistons	
Seal:	NBR 70
Back-up:	Nylon
Bearing:	Nylon
Temp:	-22 to +212° F
Pressure:	0 to 6,000 PSI
	MPSB
For 1 or 2 Piece Pistons	
Seal O.D.:	NBR 70/Fabric
Seal I.D.:	NBR 70
Bearing:	Acetal
Temp:	-22 to +212° F
Pressure:	0 to 6,000 PSI
	MNCF
For 2 Piece Pistons Only	
Seal:	NBR 70/Fabric
Back-up:	PTFE
Bearing:	Nylon
Temp:	-20 to +190° F
Pressure:	0 to 5,000 PSI

PN	OD1	Od1	Od2	L1	L2	MPSA	MPSB	MNCF
020	20.0	11.0	17.0	13.5	2.10	\$ 6.24		
022	22.0	13.0	19.0	13.5	2.10	8.80		
025	25.0	15.0	22.0	12.5	4.00	6.24		
025A	25.0	15.0	21.4	16.3	6.35	6.24		
025B	25.0	16.0	22.0	13.5	2.10	6.24		
028	28.0	19.0	25.0	13.5	2.10	6.42		
030A	30.0	21.0	27.0	13.5	2.10	6.42		
032	32.0	22.0	27.4	16.3	6.35	6.42		
032A	32.0	22.0	27.4	12.5	4.00	6.42		
032B	32.0	24.0	29.0	10.0	4.00	9.10		
032C	32.0	22.0	28.0	15.5	2.60	9.10		
032D	32.0	24.0	28.0	15.5	3.20	9.10		
035	35.0	25.0	31.4	16.3	6.35	7.20		
035A	35.0	25.0	31.0	15.5	2.60	10.09		
040D	40.0	26.0	36.0	15.5	2.60	10.76		
040E	40.0	30.0	35.4	16.3	6.35	10.76		
040F	40.0	30.0	37.0	12.5	4.00	10.76		
040G	40.0	32.0	36.0	15.5	3.20	10.76		
042	42.0	28.0	38.0	15.5	2.60	10.92		
045	45.0	35.0	40.4	16.3	6.35	11.17		
045A	45.0	29.0	40.4	18.3	6.35	11.20		
045B	45.0	31.0	41.0	15.5	2.60	11.20		
050	50.0	34.0	45.4	18.0	6.35	11.45		
050A	50.0	38.0	46.0	20.0	4.20	11.45		
050B	50.0	40.0	47.0	12.5	4.00	11.45		
050D	50.0	34.0	46.0	20.5	3.10	11.82		
055	55.0	39.0	50.4	18.3	6.40	12.67		
055B	55.0	39.0	51.0	20.5	3.10	12.20		
060	60.0	44.0	55.4	18.0	6.35	13.50		
060B	60.0	48.0	56.0	20.5	4.20	13.50		
063	63.0	47.0	58.4	19.0	6.35	14.64		
063A	63.0	51.0	59.0	20.12	4.20	14.64		
063B	63.0	53.0	60.0	12.5	4.00	14.64		
065	65.0	50.0	60.4	18.0	6.35	14.67		
070	70.0	50.0	64.2	22.0	6.35	15.00		
070	70.0	56.0	61.5	22.0	7.95			\$ 56.00
070	70.0	58.0	66.0	20.5	4.20		\$ 15.00	
070A	70.0	58.0	66.0	20.12	4.20	15.00		

Multi-Piece Piston Seals

Ordering Information

Part Number: Prefix - PN

Example: MPSA - 032A

Sizes and styles are in stock where prices are shown.

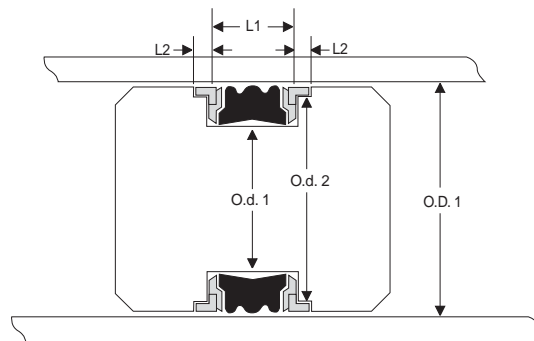

Styles



MPSA

For 1 or 2 Piece Pistons

Seal: NBR 70
 Back-up: Nylon
 Bearing: Nylon
 Temp: -22 to +212° F
 Pressure: 0 to 6,000 PSI



MPSB

For 1 or 2 Piece Pistons

Seal O.D.: NBR 70/Fabric
 Seal I.D.: NBR 70
 Bearing: Acetal
 Temp: -22 to +212° F
 Pressure: 0 to 6,000 PSI



MNCF

For 2 Piece Pistons Only

Seal: NBR 70/Fabric
 Back-up: PTFE
 Bearing: Nylon
 Temp: -20 to +190° F
 Pressure: 0 to 5,000 PSI

PN	OD1	Od1	Od2	L1	L2	MPSA	MPSB	MNCF
070B	70.0	54.0	66.0	20.5	3.10	\$ 18.50		
075	75.0	55.0	69.2	22.0	6.35	15.58		
080	80.0	60.0	74.2	22.0	6.35	17.00		
080	80.0	66.0	71.5	22.0	7.95			\$ 60.67
080A	80.0	66.0	76.0	22.12	5.20	17.00		
080C	80.0	62.0	76.0	22.0	3.60	17.00		
080D	80.0	60.0	75.0	25.0	6.35	17.00		
085	85.0	65.0	79.2	22.0	6.35	17.67		
090	90.0	70.0	84.2	22.0	6.35	19.67		
090	90.0	76.0	81.5	22.0	7.95			65.33
090	90.0	76.0	86.0	22.5	5.20		\$ 15.56	
090B	90.0	76.0	86.0	22.8	5.20	19.67		
090C	90.0	72.0	86.0	22.5	3.60	14.00		
092	92.0	82.0	88.0	12.5	6.35	26.61		
095	95.0	75.0	89.15	22.3	6.35	27.50		
100	100.0	75.0	93.2	22.0	6.35	21.25		
100	100.0	86.0	96.0	22.5	5.20		21.25	
100A	100.0	85.0	96.0	19.5	5.00	28.18		
100B	100.0	80.0	95.0	25.0	6.30	21.25		
100	100.0	86.0	91.5	22.0	9.95			74.67
100E	100.0	82.0	96.0	22.5	3.60	15.94		
100F	100.0	86.0	96.0	22.5	5.20	15.94		
105	105.0	80.0	98.2	22.0	6.35	22.33		
105A	105.0	92.5	98.8	14.3	6.35	32.17		
110	110.0	85.0	103.1	22.0	6.35	23.50		
110A	110.0	85.0	103.0	25.0	6.35	23.50		
110	110.0	96.0	101.5	22.0	9.95			84.00
110B	110.0	96.0	106.0	22.5	5.20	16.67		
110D	110.0	92.0	106.0	22.5	3.60	16.68		
115	115.0	90.0	108.1	22.0	6.35	24.42		
115B	115.0	97.0	111.0	22.5	3.60	25.02		
120	120.0	95.0	113.1	22.0	6.35	25.00		
120	120.0	106.0	111.5	22.0	9.95			84.00
120B	120.0	106.0	116.0	22.5	5.20	25.26		
125	125.0	100.0	118.1	25.0	6.35	25.50		
125A	125.0	105.0	120.0	24.5	6.35	44.44		
125	125.0	108.0	121.0	26.5	7.20		69.20	
125E	125.0	103.0	121.0	26.5	5.10	26.60		

Multi-Piece Piston Seals

Ordering Information

Part Number: Prefix - PN

Example: MPSA - 032A

Sizes and styles are in stock where prices are shown.

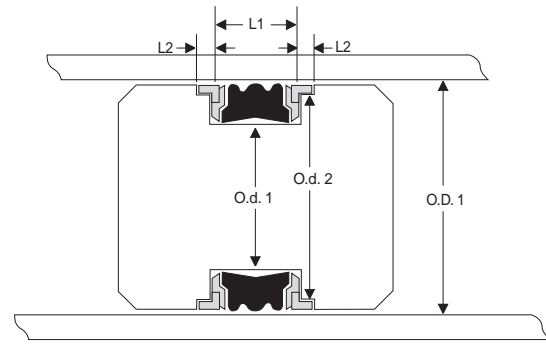

Styles



MPSA

For 1 or 2 Piece Pistons

Seal: NBR 70
 Back-up: Nylon
 Bearing: Nylon
 Temp: -22 to +212° F
 Pressure: 0 to 6,000 PSI



MPSB

For 1 or 2 Piece Pistons

Seal O.D.: NBR 70/Fabric
 Seal I.D.: NBR 70
 Bearing: Acetal
 Temp: -22 to +212° F
 Pressure: 0 to 6,000 PSI



MNCF

For 2 Piece Pistons Only

Seal: NBR 70/Fabric
 Back-up: PTFE
 Bearing: Nylon
 Temp: -20 to +190° F
 Pressure: 0 to 5,000 PSI

PN	OD1	Od1	Od2	L1	L2	MPSA	MPSB	MNCF
125F	125.0	108.0	121.0	26.5	7.20	\$ 26.60		
130	130.0	105.0	122.6	25.0	9.52	27.50		
135	135.0	110.0	128.10	25.3	6.35	28.00		
140	140.0	115.0	132.6	25.0	9.52	28.00		
140A	140.0	115.0	131.7	45.0	12.70	59.11		
140B	140.0	115.0	133.0	25.0	6.35	28.00		
140C	140.0	120.0	135.0	25.0	6.35	28.00		
150	150.0	125.0	142.6	25.0	9.52	32.17		
155	155.0	130.0	147.6	25.3	9.50	28.00		
160	160.0	135.0	152.6	25.0	9.50	29.19		
160A	160.0	130.0	153.0	25.0	6.35	37.00		
160B	160.0	140.0	155.0	25.0	6.35	37.00		
170	170.0	145.0	161.7	25.3	12.70	42.00		
170A	170.0	140.0	163.0	25.0	6.35	90.77		
175B	175.0	150.0	166.7	25.3	12.70	32.50		
180A	180.0	150.0	173.0	35.0	6.35	48.50		
180	180.0	155.0	171.1	25.0	12.70	48.50		
180	180.0	163.0	176.0	26.5	7.20		\$ 92.00	
190	190.0	165.0	181.7	25.3	12.7	54.00		
220A	220.0	195.0	211.6	25.3	12.70	58.50		

Caterpillar® Specific Piston Seals

Ordering Information

Part Number: CTC-Caterpillar® Part Number

Example: CTC-9X7298

Sizes and styles are in stock where prices are shown.

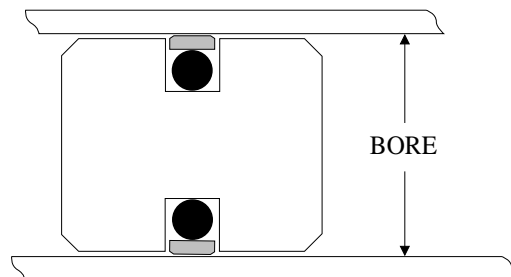

Styles



2-Piece
PISTON SEAL

Piston Seal: PTFE
Energizer: Nitrile 70
Temperature: -40 to +220° F
Pressure: 0 to 5,000 PSI

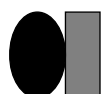

2-Piece
STEP CUT PISTON SEAL

Seal: Nylon
Energizer: Nitrile 70
Temperature: -40 to +220° F
Pressure: 0 to 5,000 PSI



4-Piece
PISTON SEAL

Piston Seal: PTFE
Back-ups: Nylon
Energizer: Buna N
Temperature: -20 to +225° F
Pressure: 0 to 6,000 PSI



5-Piece
PISTON SEAL

Seal: NBR 70/Fabric
Back-up: PTFE
Bearing: Nylon
Temp: -20 to +190° F
Pressure: 0 to 5,000 PSI

PART NUMBER	BORE	2 PC	2 PC-SC	4 PC	5 PC
CTC-1200890	75	\$12.17			
CTC-9X7298	100		\$ 56.17		
CTC-9X7301	110		66.67		
CTC-9X3592	120		66.67		
CTC-9X3595	130		66.67		
CTC-9X3598	140		60.72		
CTC-9X3601	150		60.33		
CTC-9X3604	160		60.33		
CTC-9X3607	170		64.96		
CTC-9X3610	180		64.94		
CTC-0996998	80			\$ 28.72	
CTC-0996973	90			33.00	
CTC-5I5928	100			35.64	
CTC-0996922	110			37.20	
CTC-A04601713	110			37.20	
CTC-A04601719	160			65.16	
CTC-A04601215	110				\$ 84.00
CTC-A04601216	120				84.00

NOTE: These seals are specials for certain Caterpillar® cylinders and groove dimensions are unknown. Do not use unless you are ordering by the specific Caterpillar® part number.

NOTE: Caterpillar® part numbers are used as a reference only. We do not imply that these parts are original equipment parts.

Piston Rings



Ordering Information

Part Number: Prefix - OD X WX RW

Example: MSPR- 27.85 X 2.18 X 1.31

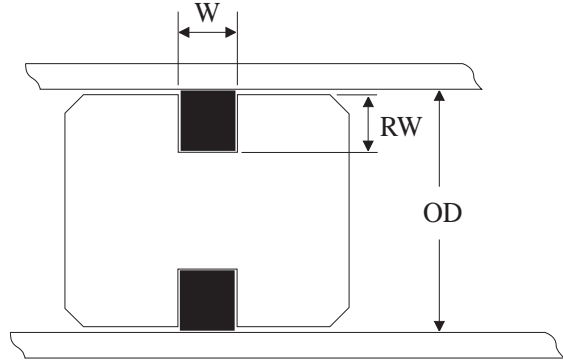
Sizes and styles are in stock where prices are shown.



Styles	
	MSPR
Material:	Cast Iron
	MBR
Material:	Bronze

OD	W	RW	MSPR	MBR
27.85	2.18	1.31	\$ 4.14	
40.0	2.0	2.0	8.11	
45.0	2.5	2.2	8.11	
46.0	2.2	2.2	5.07	
47.9	2.6	2.2	5.07	
49.9	2.2	2.2	5.07	
50.0	2.0	2.0	8.11	
50.0	2.5	2.3	8.11	
52.0	2.12	2.1	5.54	
55.0	3.0	2.3	9.05	
70.0	6.0	6.0		\$ 23.94
80.0	6.0	6.0		30.01
90.0	4.0	3.5	14.70	
95.0	4.0	4.0	17.64	
105.0	4.0	4.4	18.00	
115.0	4.0	4.7	33.25	
120.0	4.0	5.0	35.47	
130.0	4.0	5.4	37.68	
135.0	4.0	5.4	23.10	
135.0	5.5	4.0	23.10	
140.0	4.0	5.7	27.30	
160.0	4.0	6.55	31.92	
185.0	4.0	7.55	38.64	